

Ventajas Comparativas de Aplicaciones de Secciones Tubulares en Chile

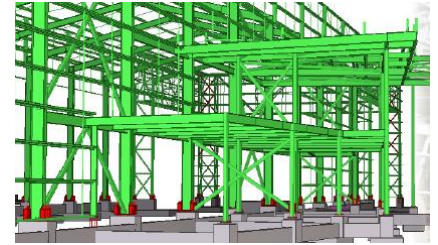

AMCS es una empresa que se dedica al desarrollo de proyectos tipo EPC:

- Diseño Estructural, Detallamiento de Planos de Fabricación de Estructuras de Acero y Barras de Hormigón
- Fabricaciones en Acero
- Montaje y Construcción

Ejemplos Algunos Proyectos Desarrollados



Bodegas Los Pinos



15.000 m2 bodegas

Buenaventura Center

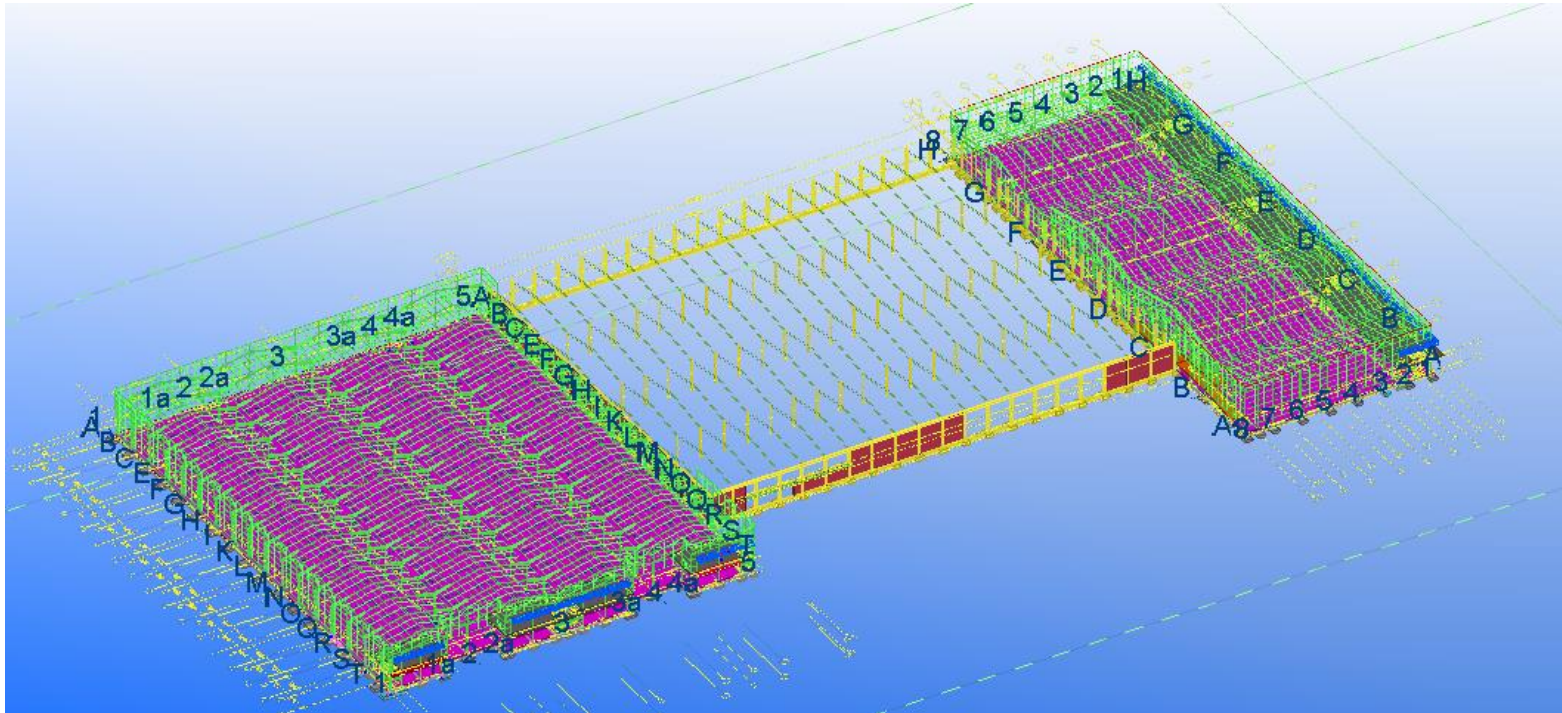

20000 m2 de bodegas y oficinas

AMCS
SOLUCIONES EN ACERO

Ingeniería
Fabricación
Montaje
Construcción



Colegios Varios



Supermercados Varios



Bodegas HJ - Pudahuel



Marcos Rígidos Sentido Transversal



AkiKB Viña del Mar



Bodegas Multinivel y Oficinas de 8500 m2

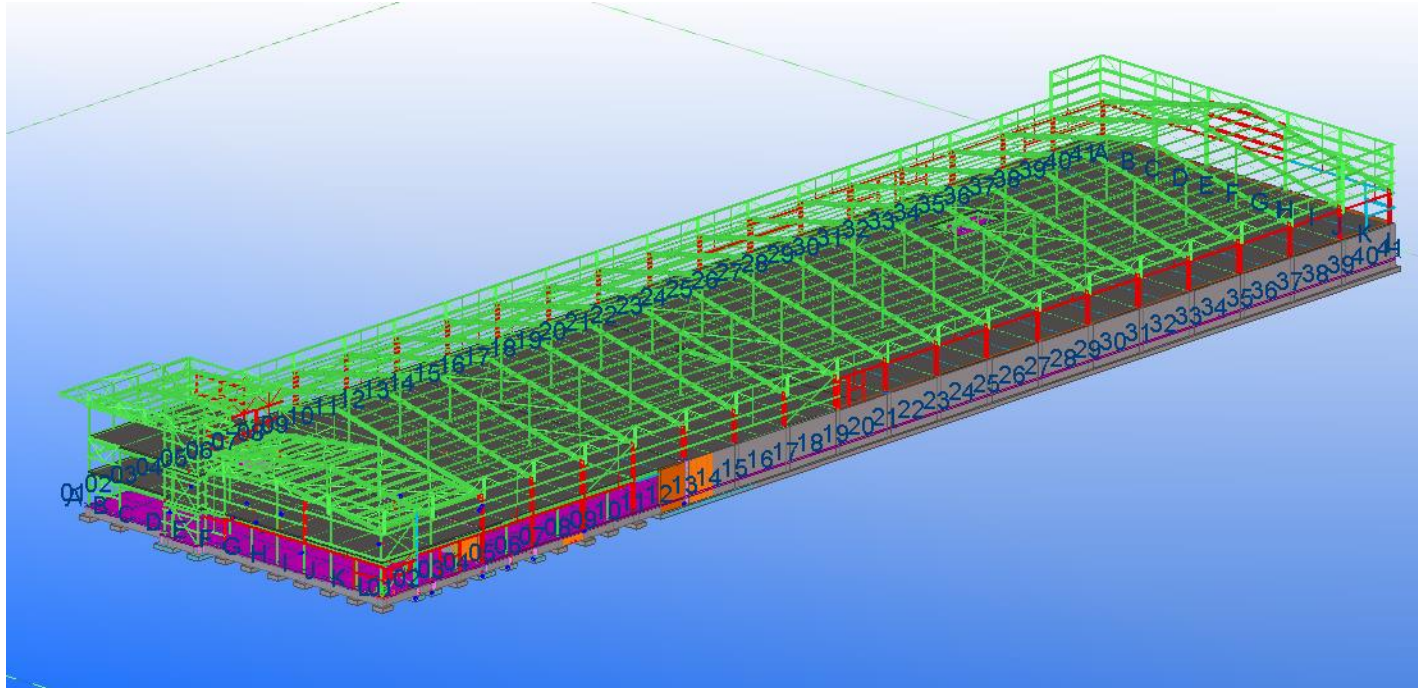

AMCS
SOLUCIONES EN ACERO

Ingeniería
Fabricación
Montaje
Construcción



AkiKB Enea



Bodegas 11900 m2 en 5 niveles

AMCS
SOLUCIONES EN ACERO

Ingeniería
Fabricación
Montaje
Construcción



AMCS
SOLUCIONES EN ACERO

Ingeniería
Fabricación
Montaje
Construcción



AMCS
SOLUCIONES EN ACERO

Ingeniería
Fabricación
Montaje
Construcción



Grupo AMCS – Camino Internacional 4700, Viña del Mar, Chile
+56-2-2897 9100 info@amcs.cl www.amcs.cl

¿Por qué HSS?

Secciones Disponibles en Chile

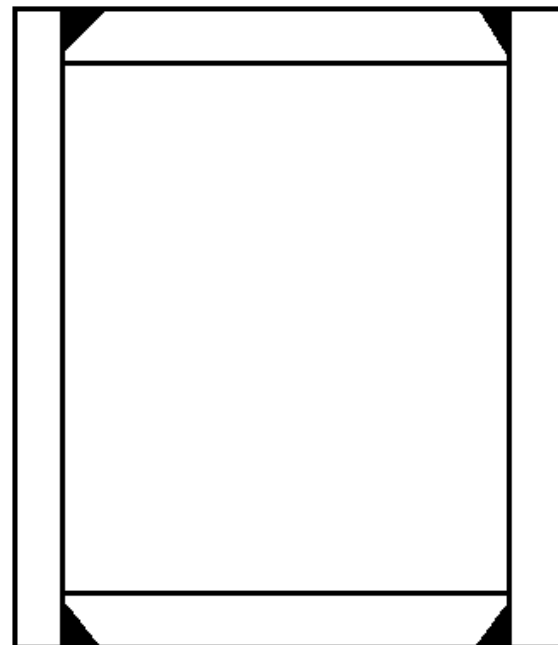
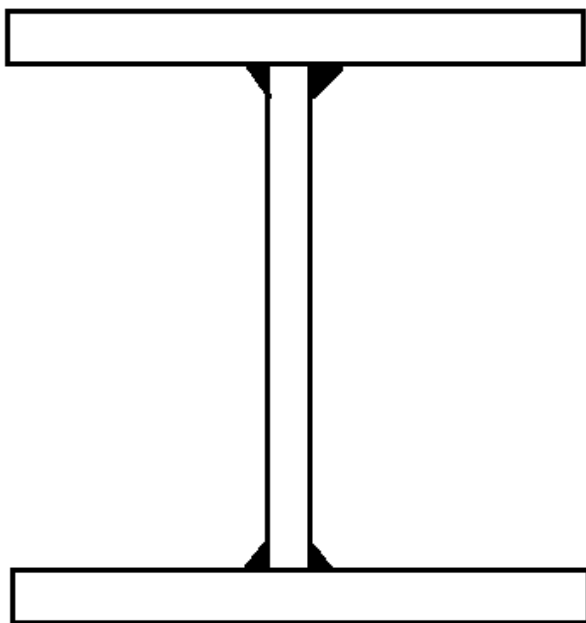

Nuevas Secciones Disponibles

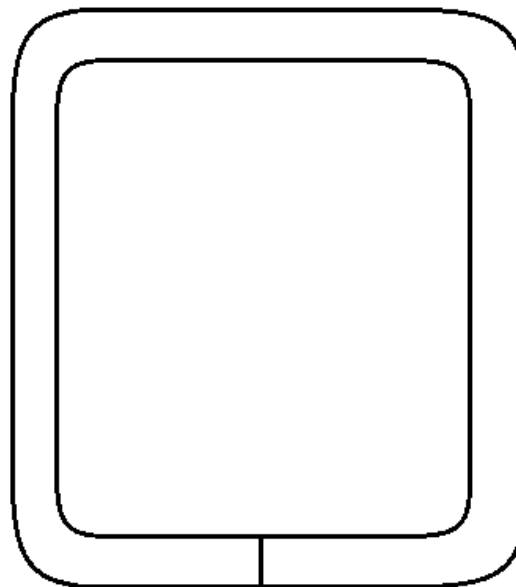
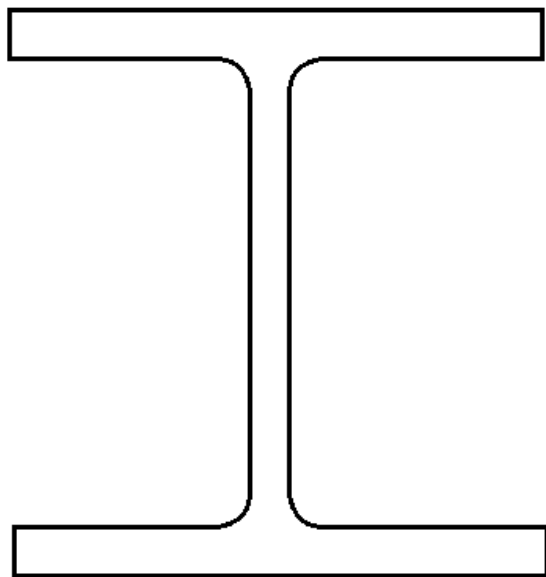

Casos de Estudio y Experiencia Local

Edificio San Martín – Santiago Centro



Edificio San Martín – Santiago Centro

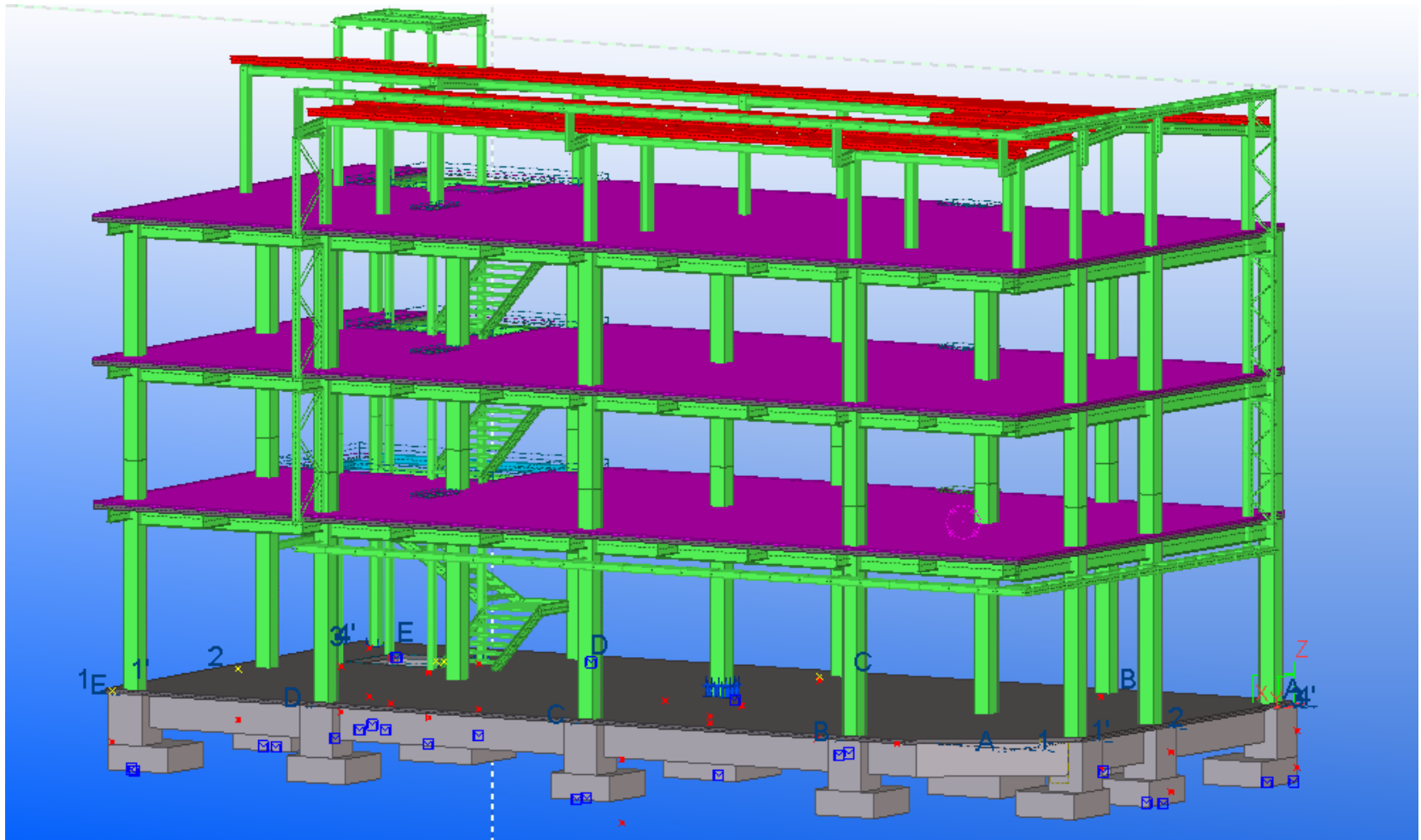

Alternativa Original

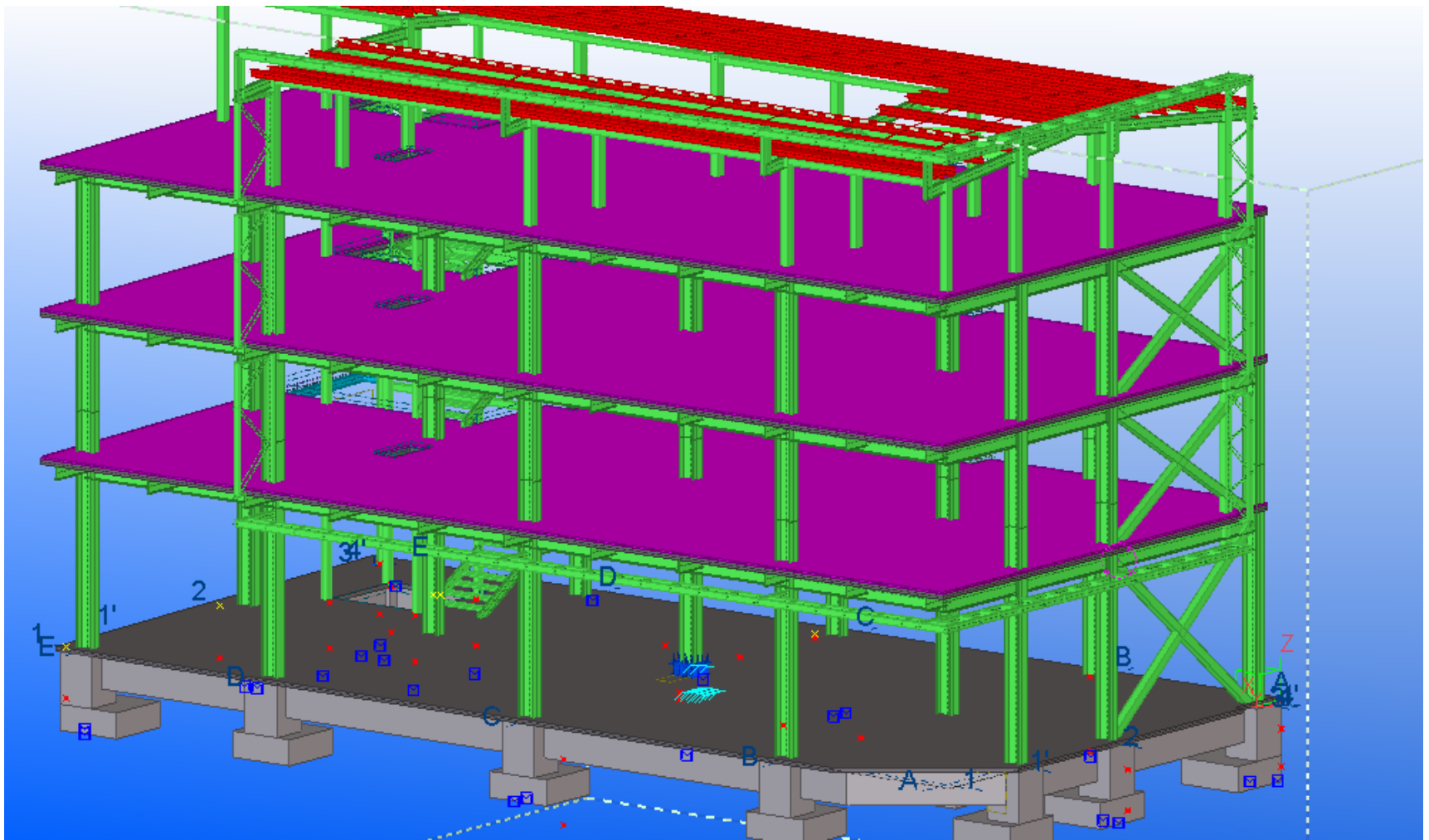

Marco Arriostrado y Marco Rígido

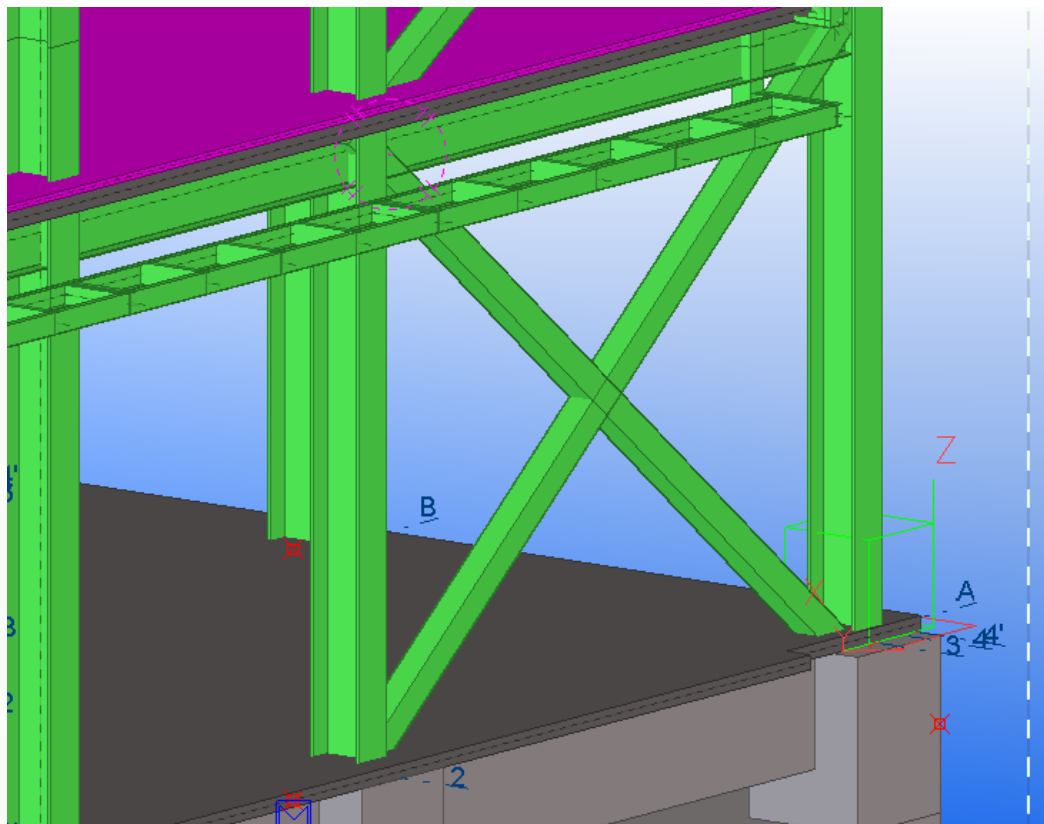



Libertad en Planta

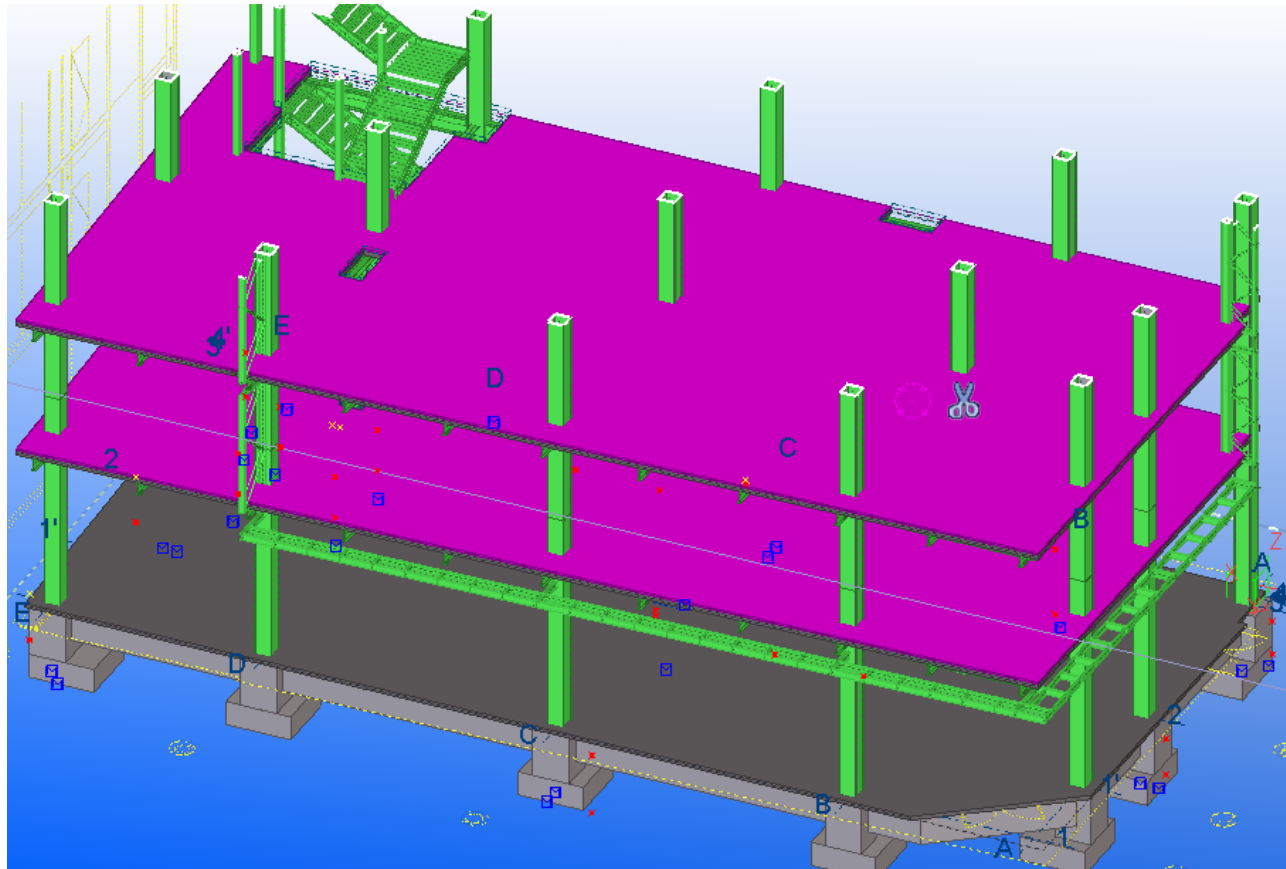

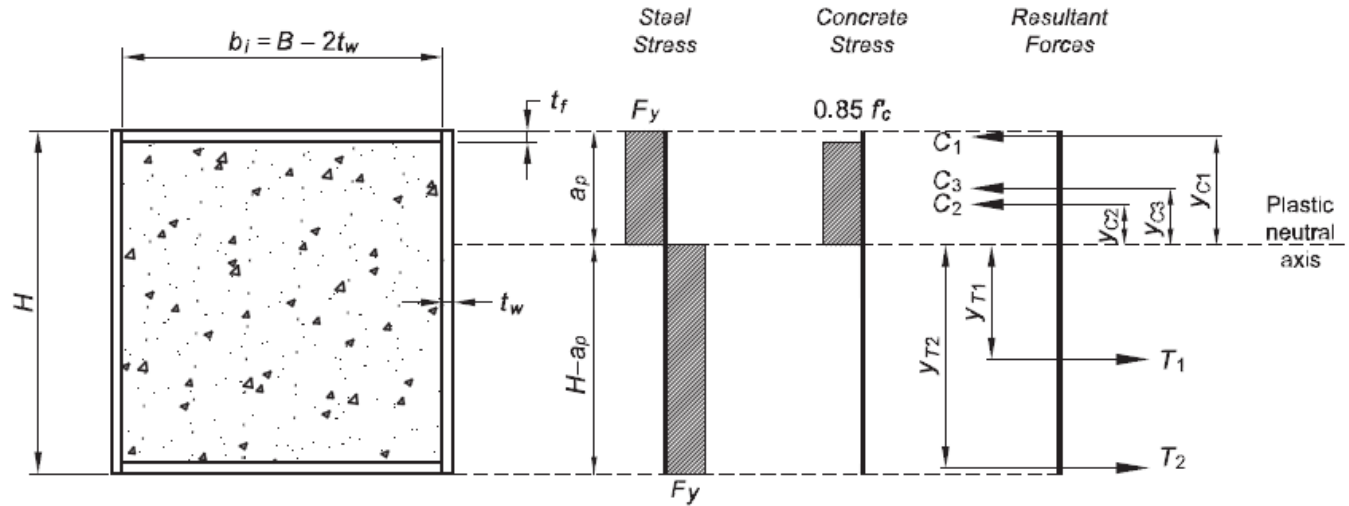

Figure I.7-2. Plastic moment stress blocks and force distribution.

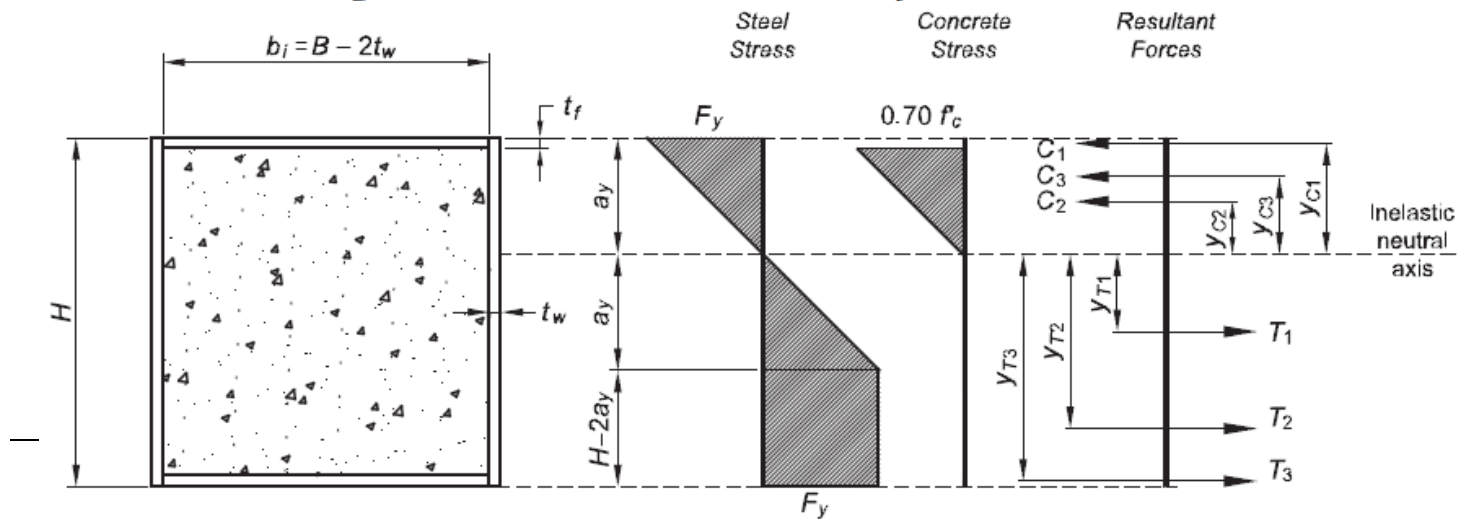
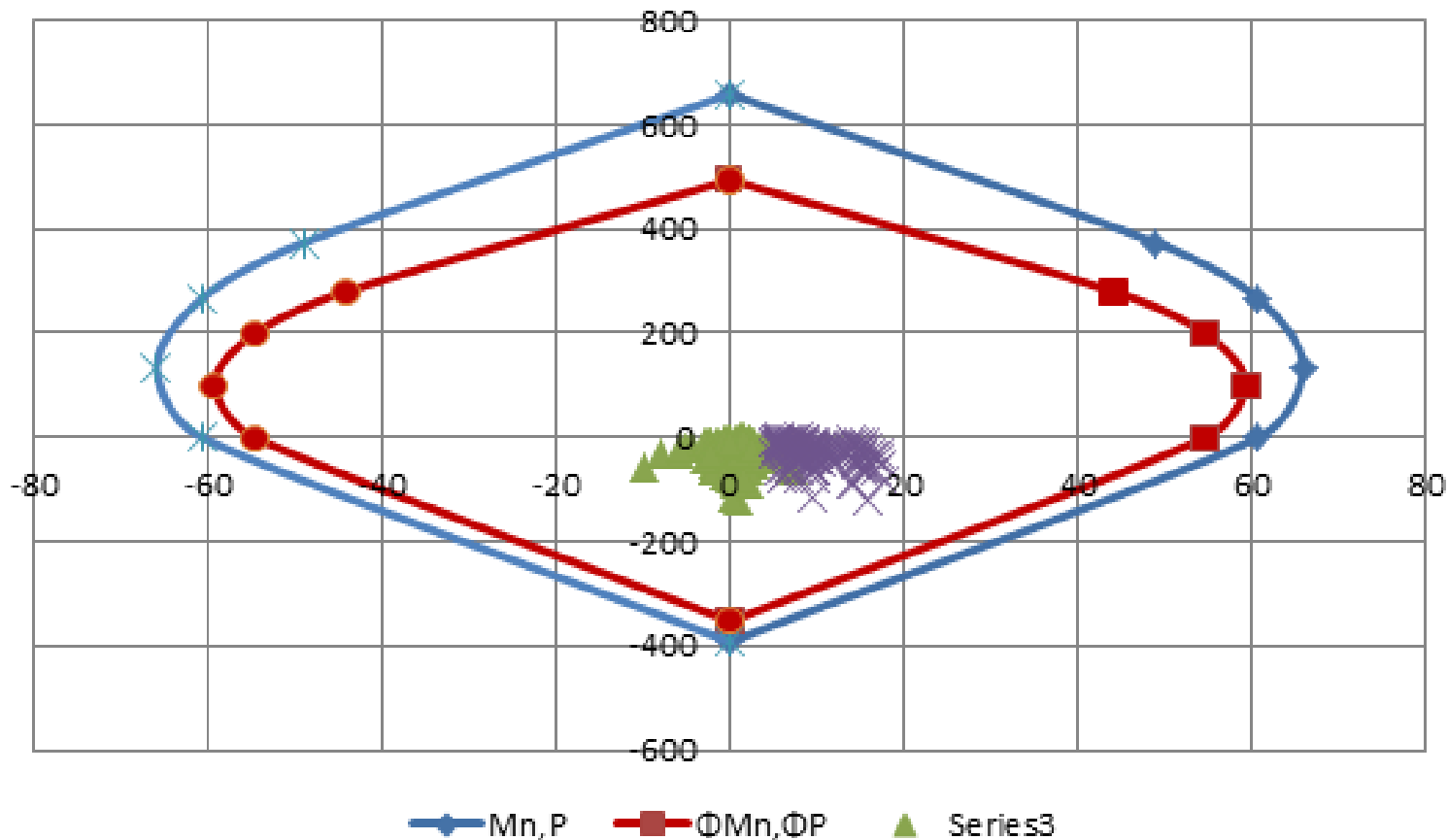
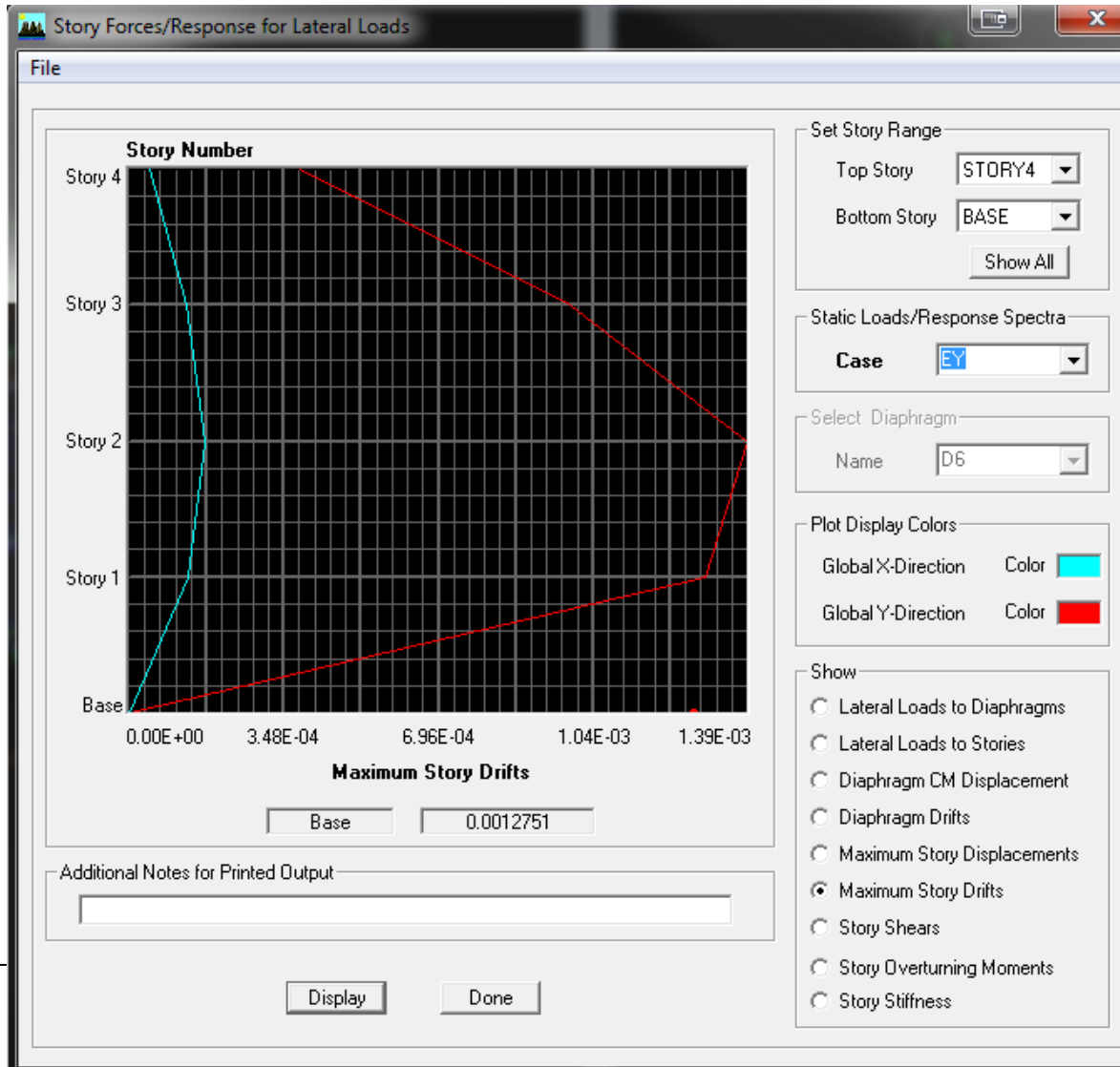

Figure I.7-3. Yield moment stress blocks and force distribution.

DI - Columna Compuesta 400x400x10mm





Edificio 8 Pisos + 2 Subterráneos



Edificio 8 Pisos + 2 Subterráneos

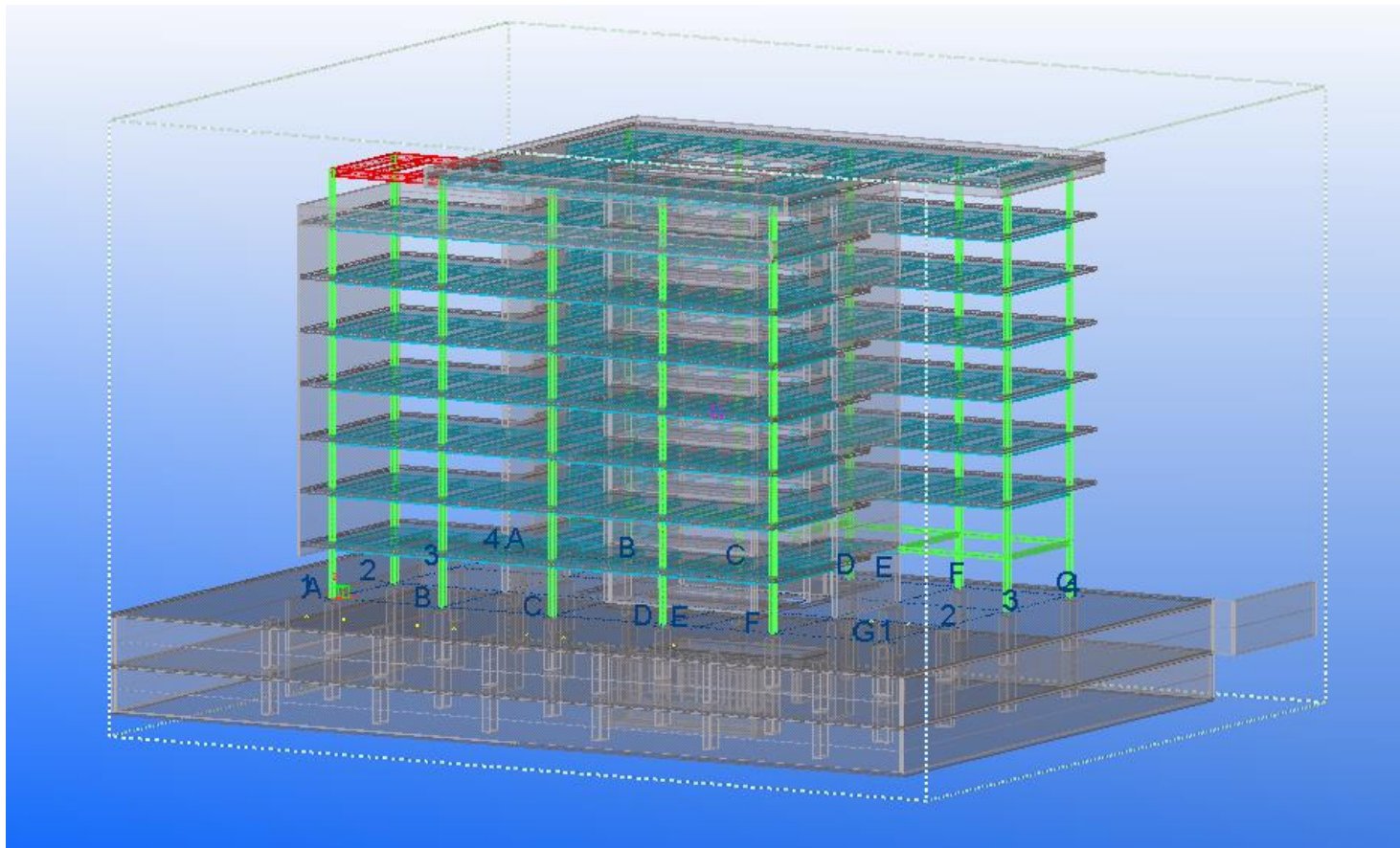

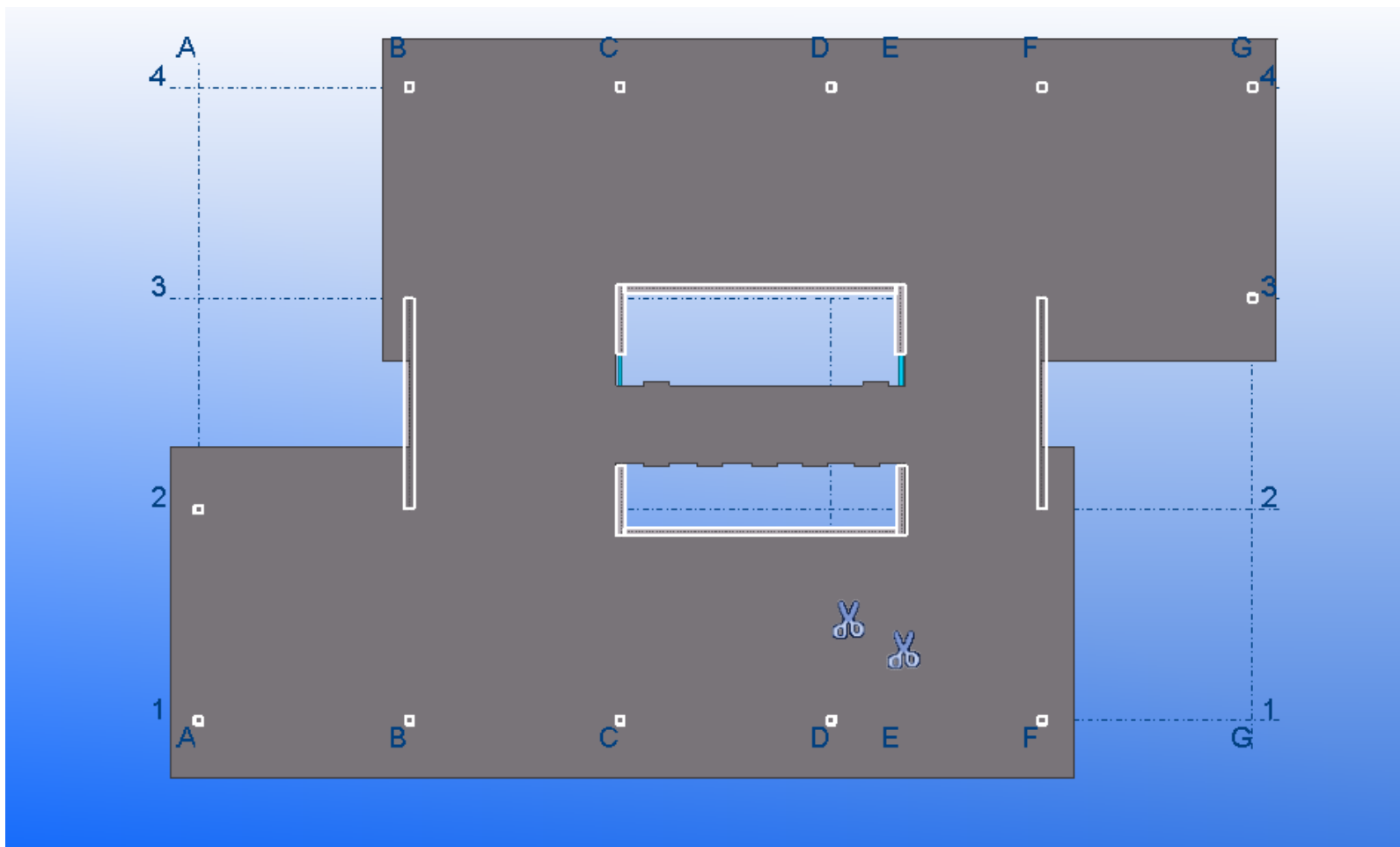

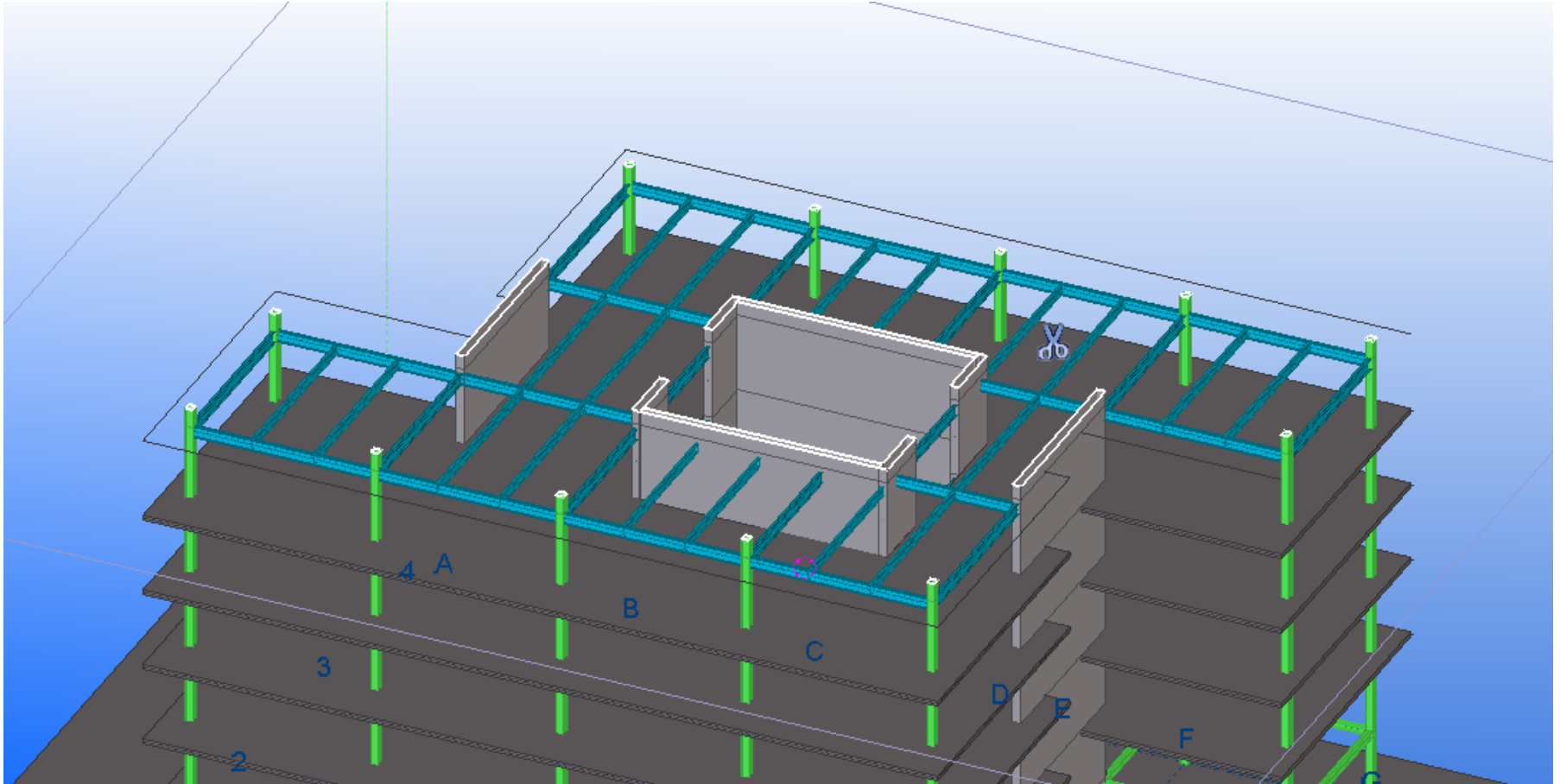

Edificio 10 Pisos + 2 Subterráneos

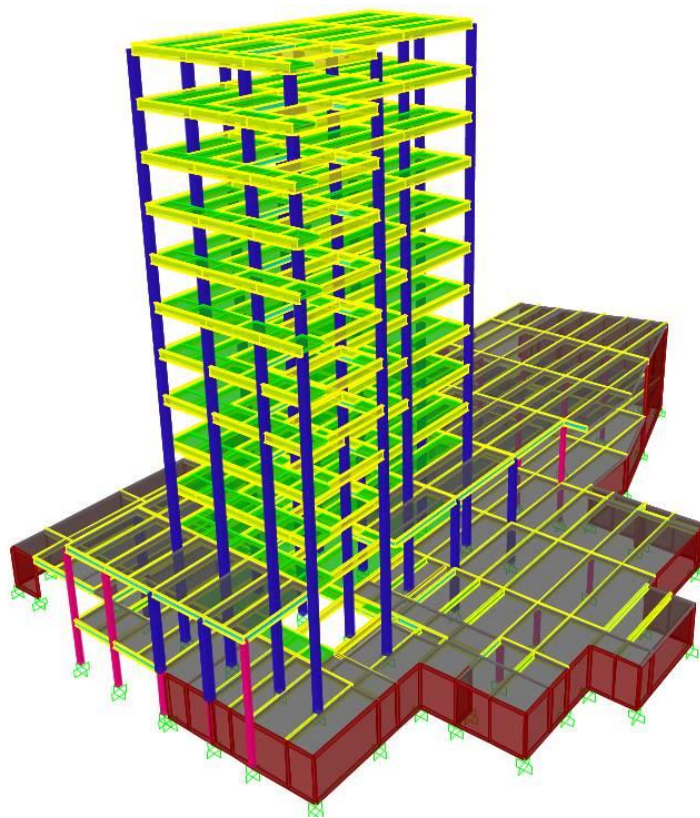

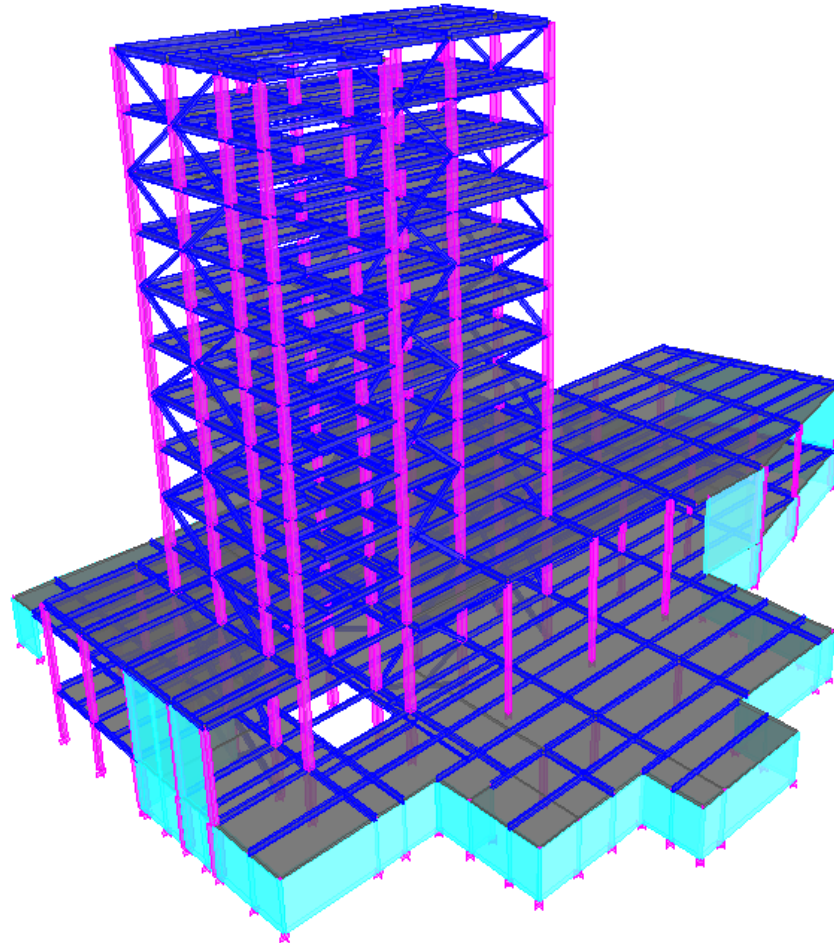

Centro Bodegaje Noviciado

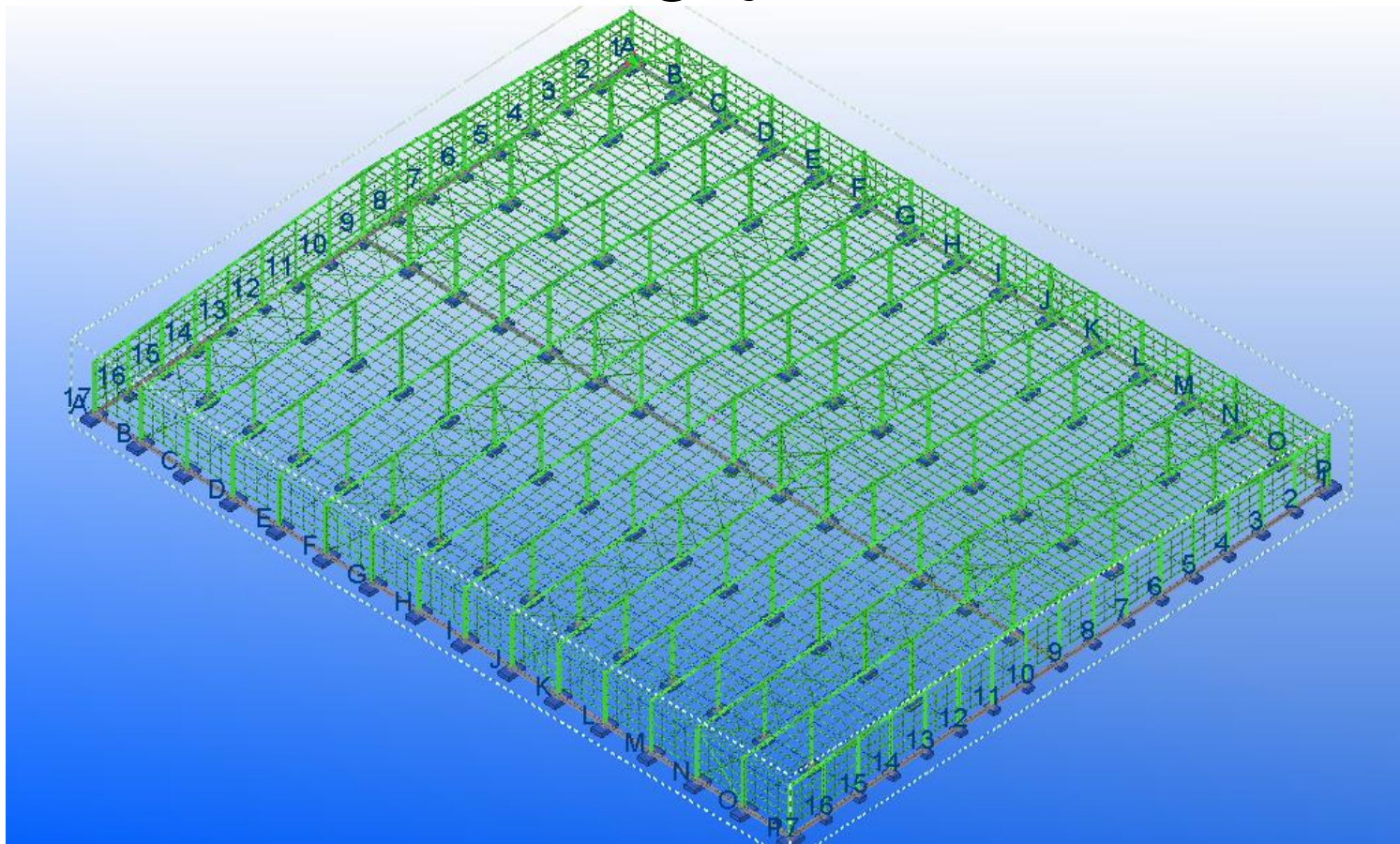

Marco Tipo



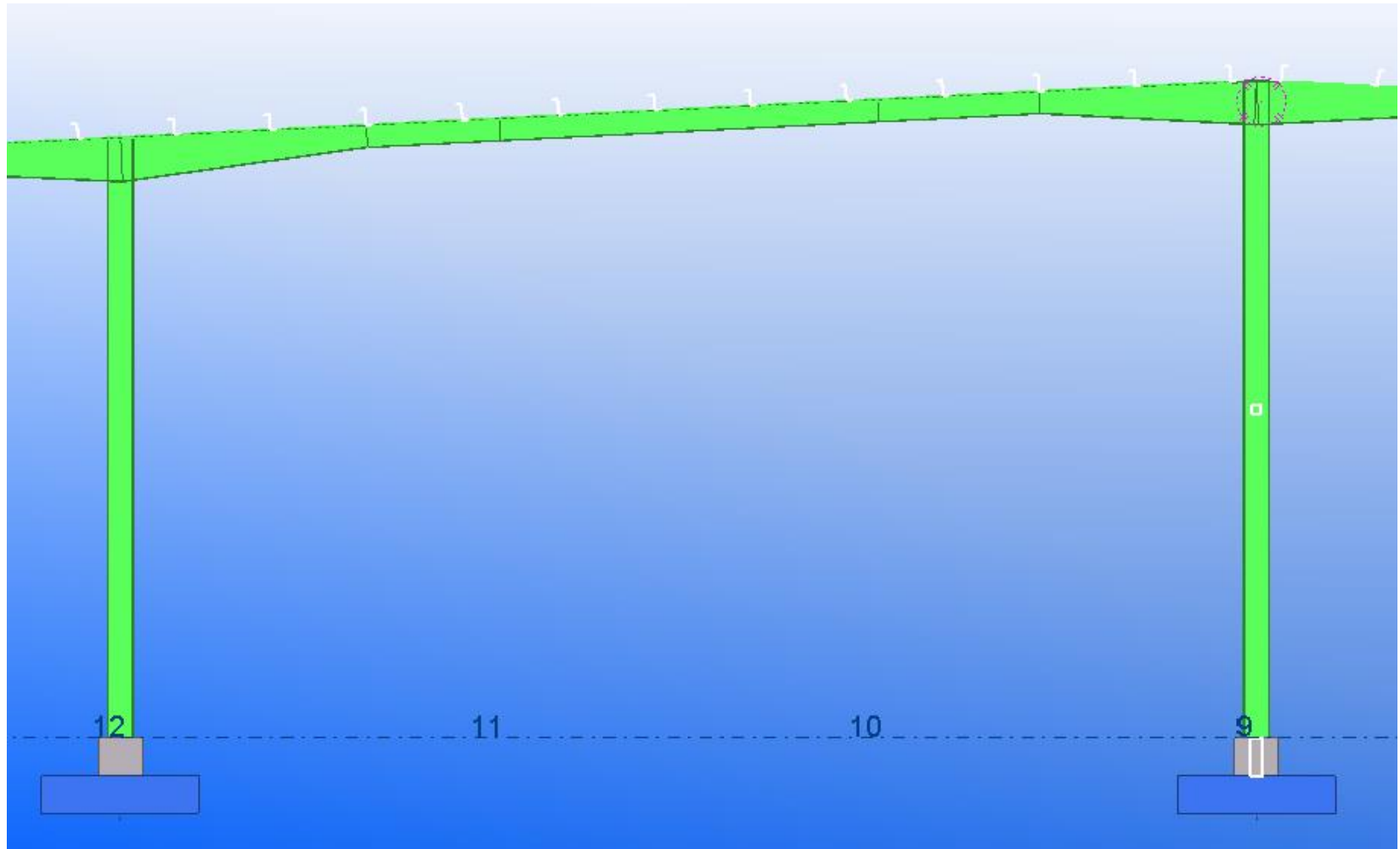

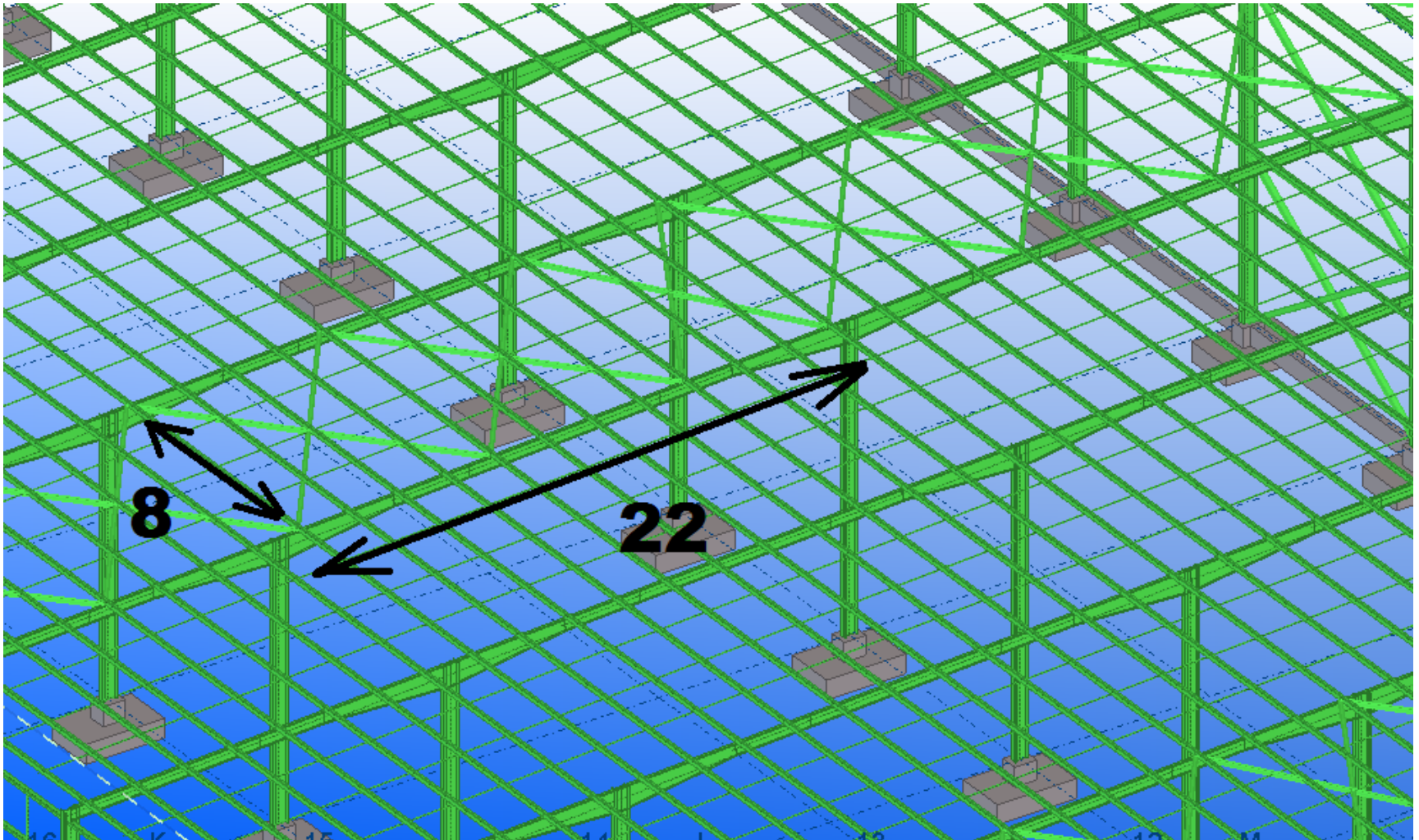

Marcos Rígidos en 2 Sentidos

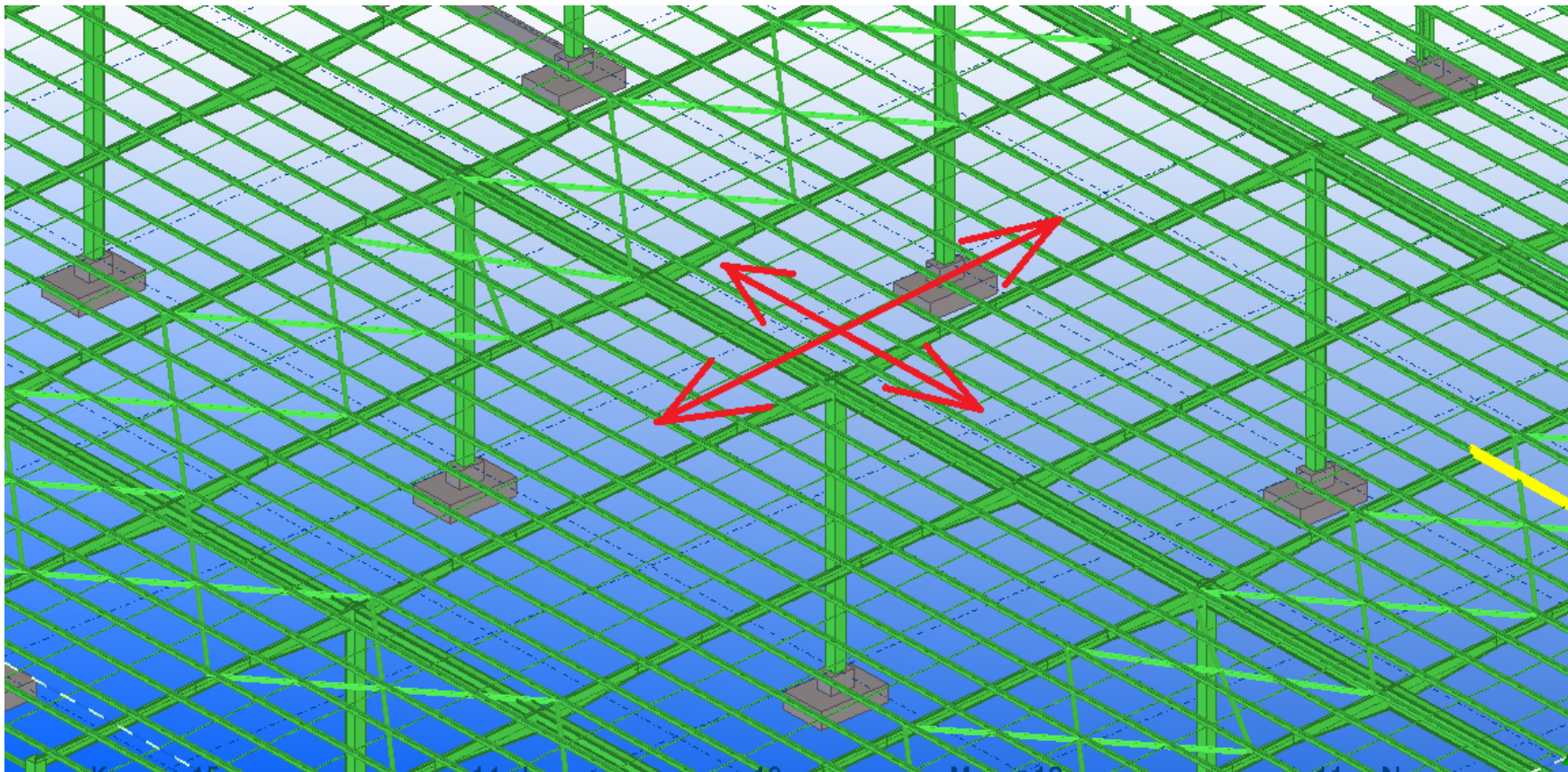

Cambio a Columnas HSS

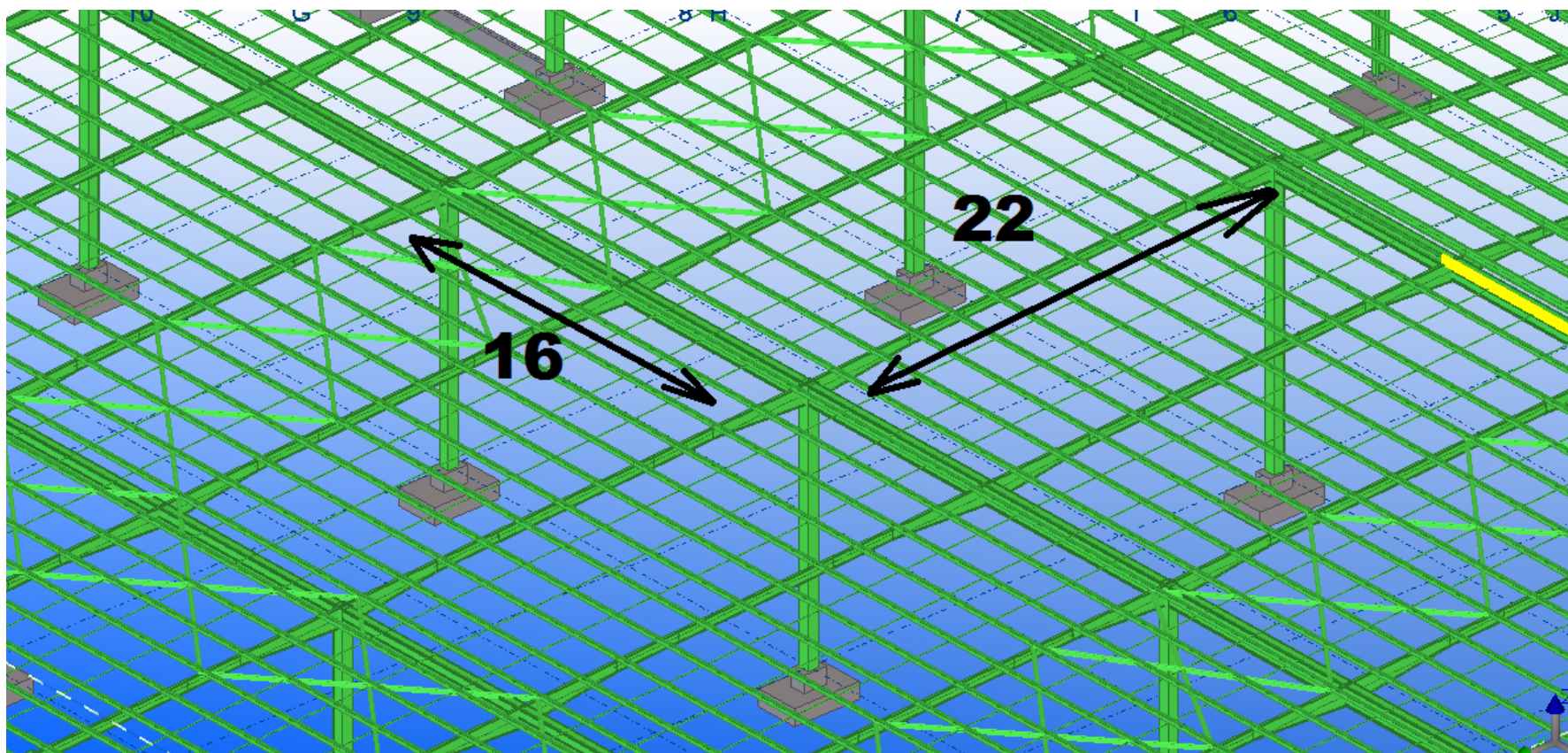

Conexiones



Conexión de Momento



Conexiones de Momento

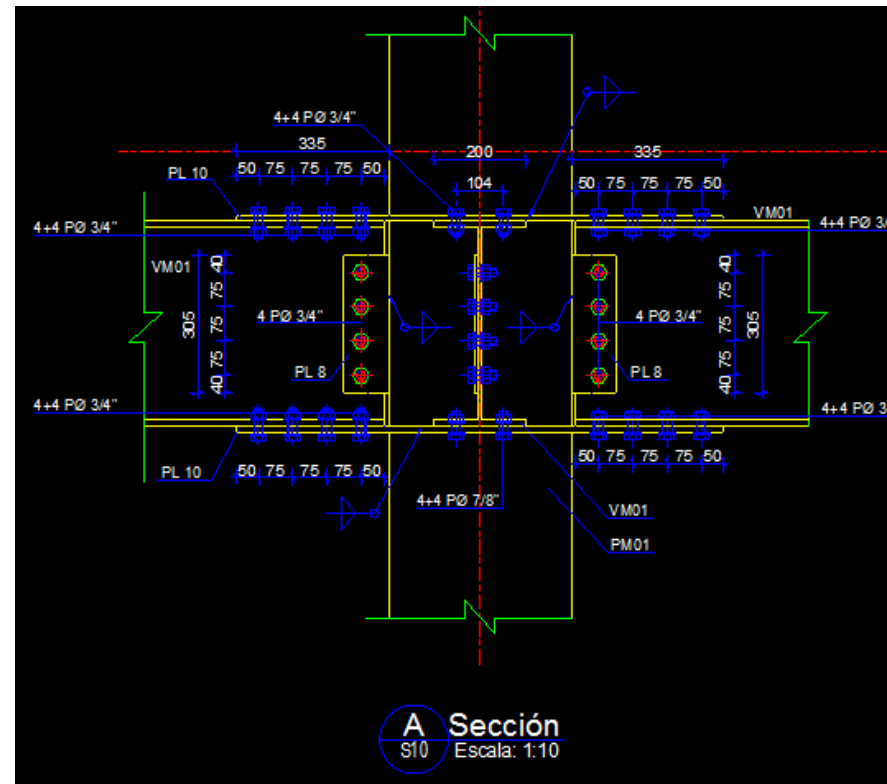
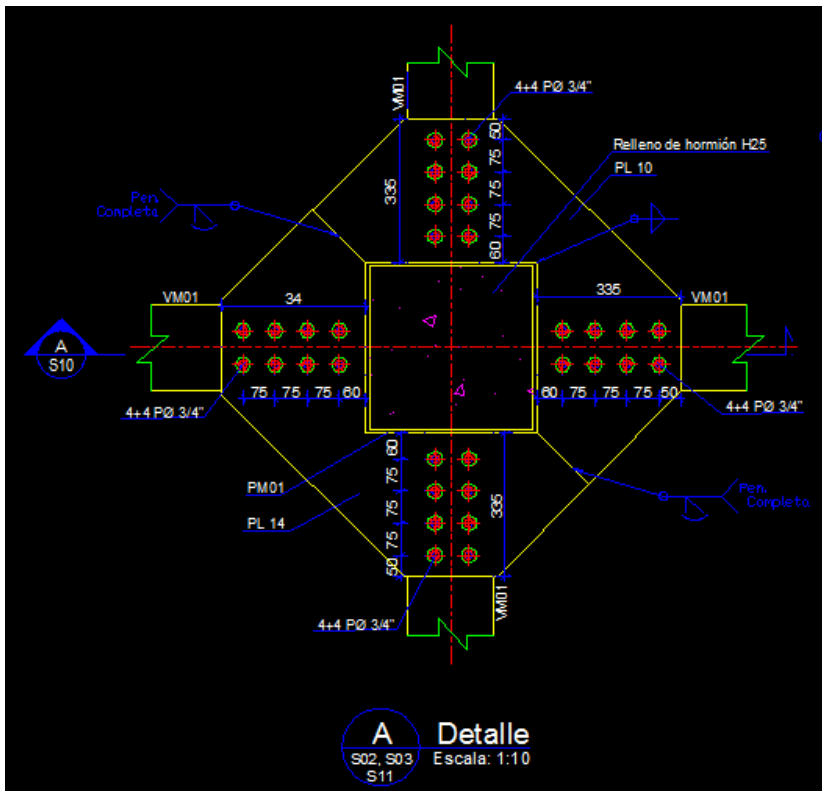

AMCS
SOLUCIONES EN ACERO

Ingeniería
Fabricación
Montaje
Construcción

Type HB - Hollo-Bolt®



lindapter®

¡Muchas gracias!

info@amcs.cl